

# 2.CKL SERIES

## L Brackets Mounting Dry Type Power Transformer

## EI120/41

2.CKL Series



- Rated power: 300VA
- Safety Isolating & Isolating Transformers
- Non-short-circuit proof
- Ambient temperature 40°C
- Temperature Class B
- Self-extinguishing plastics UL94HB
- Degree of protection IP00
- Clamp Terminals for Currents up to 60A
- Moisture protected by varnish
- High electrical safety and long service-life features
- In compliance with: EN61558-1, EN61558-2-4, EN61558-2-6
- Weight: 4050 g

### Approvals:



### Electrical Data:

Primary Voltage	Secondary Voltage			Voltage Drop	Rated Power	Width*	Safety Isolating / Isolating transformers	2.CKL Series
	With Load		No Load					
[V]	[V]	@ [A]	[V]	[%]	[VA]	B / C[mm]	[SIT / IT]	Order code
230	12	25.0	12.8	7	300	98 / 68.5	SIT	2.CKL.E12041.209
230	2 x 12	12.5	2 x 12.8	7	300	98 / 68.5	SIT	2.CKL.E12041.210
230	21	14.3	22.5	7	300	98 / 68.5	SIT	2.CKL.E12041.215
230	24	12.5	25.7	7	300	98 / 68.5	SIT	2.CKL.E12041.217
230	2 x 24	6.25	2 x 25.7	7	300	98 / 68.5	SIT	2.CKL.E12041.218
230	36	8.33	38.5	7	300	98 / 68.5	SIT	2.CKL.E12041.221
230	42	7.14	44.9	7	300	98 / 68.5	SIT	2.CKL.E12041.223
230	48	6.25	51.4	7	300	98 / 68.5	SIT	2.CKL.E12041.225
230	42, 48	6.25	44.9, 51.4	7	300	98 / 68.5	SIT	2.CKL.E12041.240
230	115	2.61	123	7	300	98 / 68.5	IT	2.CKL.E12041.260
230	230	1.30	246	7	300	98 / 68.5	IT	2.CKL.E12041.270
230	400	0.75	428	7	300	98 / 68.5	IT	2.CKL.E12041.280
400	12	25.0	12.8	7	300	98 / 68.5	SIT	2.CKL.E12041.409
400	2 x 12	12.5	2 x 12.8	7	300	98 / 68.5	SIT	2.CKL.E12041.410
400	21	14.3	22.5	7	300	98 / 68.5	SIT	2.CKL.E12041.415
400	24	12.5	25.7	7	300	98 / 68.5	SIT	2.CKL.E12041.417
400	2 x 24	6.25	2 x 25.7	7	300	98 / 68.5	SIT	2.CKL.E12041.418
400	36	8.33	38.5	7	300	98 / 68.5	SIT	2.CKL.E12041.421
400	42	7.14	44.9	7	300	98 / 68.5	SIT	2.CKL.E12041.423
400	48	6.25	51.4	7	300	98 / 68.5	SIT	2.CKL.E12041.425
400	42, 48	6.25	44.9, 51.4	7	300	98 / 68.5	SIT	2.CKL.E12041.440
400	115	2.61	123	7	300	98 / 68.5	IT	2.CKL.E12041.460
400	230	1.30	246	7	300	98 / 68.5	IT	2.CKL.E12041.470
400	400	0.75	428	7	300	98 / 68.5	IT	2.CKL.E12041.480

\* See Mechanical Data

# 2.CKL SERIES

## L Brackets Mounting Dry Type Power Transformer

## EI120/41

### Possible Connection Types:

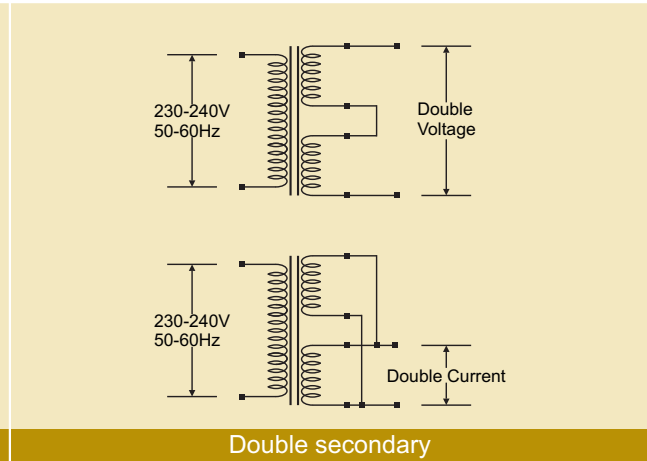
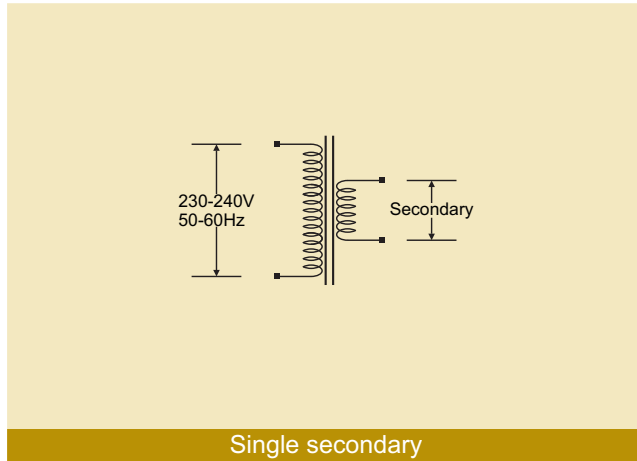

### Mechanical Data:

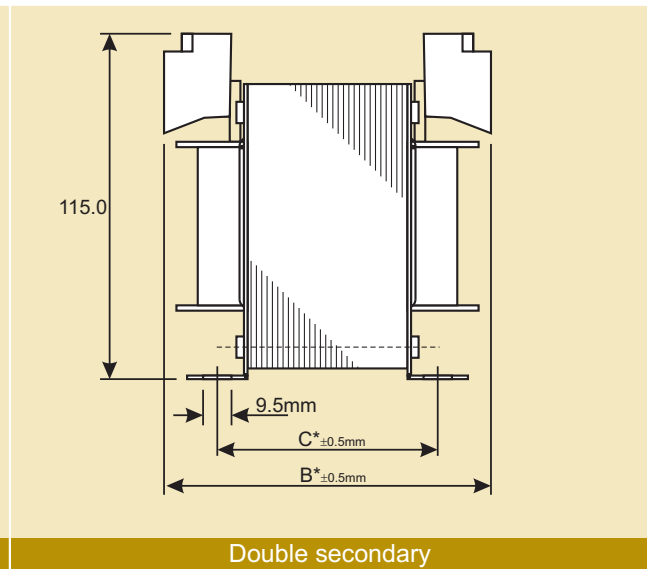
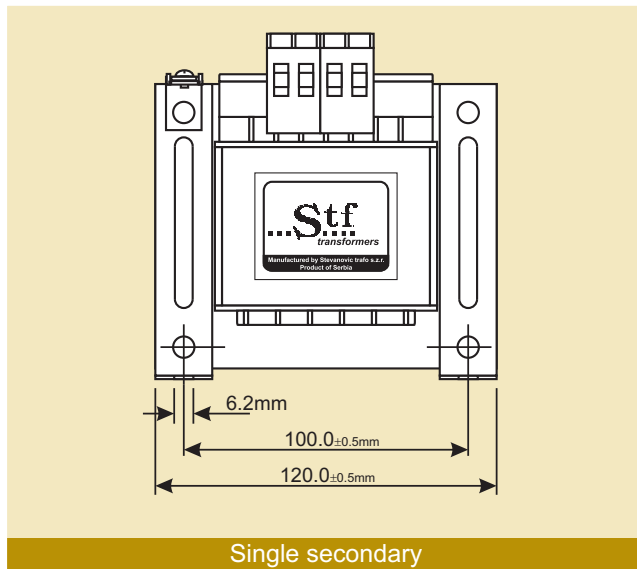

\*Transformer width is given in table with Electrical Data

### Types available on request:

Primary Voltage	Secondary Voltage			Voltage Drop	Rated Power	Width*	Safety Isolating / Isolating transformers	9.xxx Series
	With Load		No Load					
[V]	[V]	@ [A]	[V]	[%]	[VA]	B / C[mm]	[SIT / IT]	Order code
<600			<400	7	300	98 / 70.0	IT	9.xxx.E12041.xxx
<600			<400	7	400	110 / 82.0	IT	9.xxx.E12053.xxx
<600			<400	7	450	118 / 90.0	IT	9.xxx.E12061.xxx
<600			<400	7	500	130 / 102.0	IT	9.xxx.E12073.xxx

\*See Mechanical Data